



INSTALLATION INSTRUCTIONS FOR PART 95-7332

APPLICATIONS

Hyundai Elantra (Radio Delete Models) 2007-2010

95-7332

KIT FEATURES

- Double DIN Radio Provision
- Stacked ISO Mount Units Provision

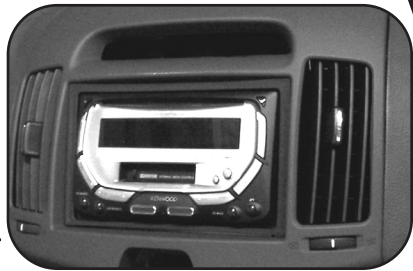

KIT COMPONENTS

- A) Double DIN Trim Plate B) Double DIN Brackets

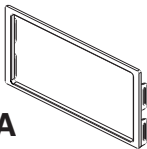

A

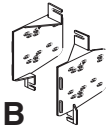

B

Wiring & Antenna Connections (sold separately)

- 70-1004 - Hyundai 2006-up / Kia 2004-up Harness
- 70-7303 - Hyundai / Kia Harness 2009
- 40-K111 - Kia Antenna Adapter 2007-up

TOOLS REQUIRED:

- Small Flat Blade Screwdriver/ Panel Removal Tool
- Phillips Screwdriver



1-800-221-0932



www.metraonline.com

© COPYRIGHT 2010 METRA ELECTRONICS CORPORATION



TABLE OF CONTENTS

Dash Disassembly

- Hyundai Elantra (Radio Delete Models) 2007-2010 1

Kit Assembly

- Double DIN/Stacked ISO Mount Units Provision 2

Final Assembly 3

***Note:**

Refer also to the instructions included with the aftermarket radio.

HYUNDAI ELANTRA 2007-2010

- 1** Disconnect the negative battery terminal to prevent an accidental short circuit.
- 2** Unclip the panel surrounding the radio including the a/c vents and hazard switch. Unplug the hazard switch and remove the panel. (Figure A)
- 3** Remove (4) Phillips screws securing the blank plate/pocket covering the radio cavity and remove the plate. (Figure B)

Continue to kit assembly.

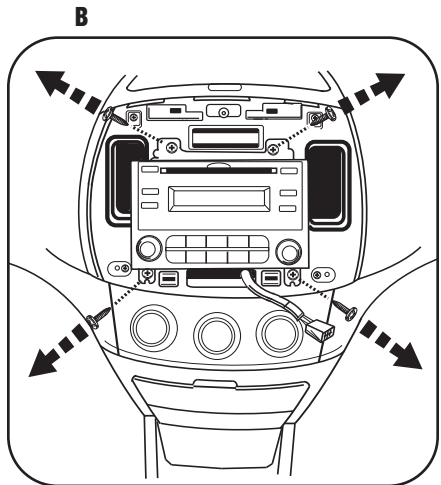
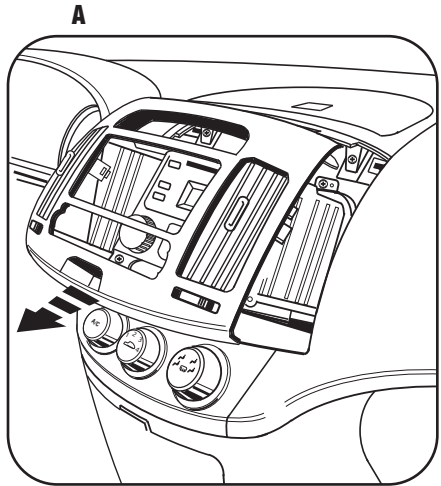

DOUBLE DIN RADIO PROVISION STACKED ISO MOUNT UNITS PROVISION

**Note: Refer also to the instructions included with the aftermarket radio.*

- 1** Snap the Double DIN brackets to the inside edge of the Double DIN trim plate. (Figure A)
- 2** Slide the Double DIN or stacked ISO mount unit(s) into the bracket/trim plate assembly and secure the unit(s) to the assembly using the screws supplied with the unit(s). (Figure B)

Continue to final assembly.

A

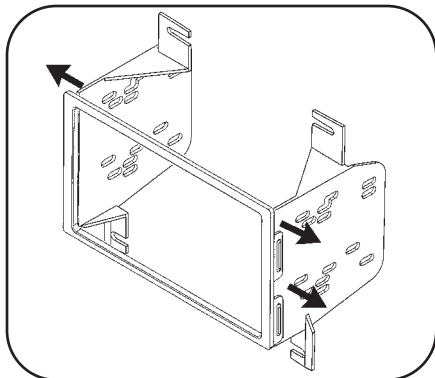

B

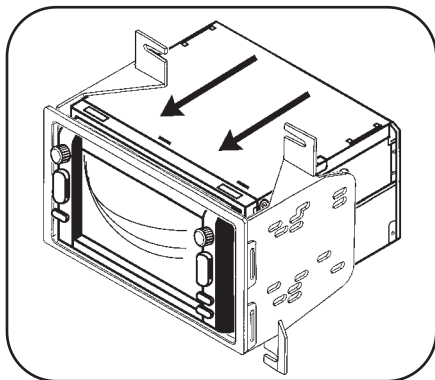

FINAL ASSEMBLY

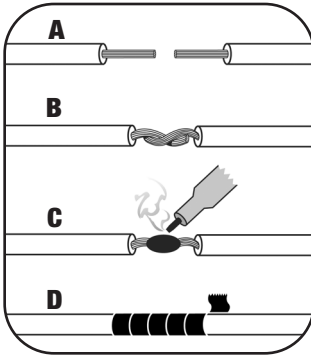

(A) Strip wire ends back 1/2"

B) Twist ends together

C) Solder

D) Tape

- 1 Locate the factory wiring harness in the dash. Metra recommends using the proper mating adapter and making connections as shown. (Isolate and individually tape off the ends of any unused wires to prevent electrical short circuit.)
- 2 Re-connect the negative battery terminal and test the unit for proper operation.
- 3 Reassemble radio and dash assemblies in reverse order of disassembly.

FINAL WIRING CONNECTIONS

Make wiring connections using the EIA color code chart shown below and the instructions included with the head unit. Metra recommends making connections as shown below; Strip, Splice, Solder, Tape. Isolate and individually tape off ends of any unused wires to prevent electrical short circuit.

METRA / EIA WIRING CODE

12V Ignition / Acc. Red	Right Front (+) Gray
12V Batt / Memory. Yellow	Right Front (-). Gray/ Black
Ground Black*	Left Front (+) White
Power Antenna. Blue	Left Front (-). White / Black
Amp Turn-On Blue / White	Right Rear (+) Violet
Amp Ground. Black / White	Right Rear (-). Violet / Black
Illumination Orange	Left Rear (+) Green
Dimmer Orange / White	Left Rear (-) Green / Black

***NOTE:** When a Black wire is not present, ground radio to vehicle chassis.

All colors may not be present on all leads due to manufacturer's specifications.

NOTES

95-7332 INSTRUCTIONS



1-800-221-0932



www.metraonline.com

REV. 04/30/10 © COPYRIGHT 2010 METRA ELECTRONICS CORPORATION INST95-7332